

# ÖZGÜR<sup>®</sup>

GAS ARMATURES



*Çalışmadan, yorulmadan ve üretmeden, rahat yaşamak isteyen toplumlar; evvela haysiyetlerini, sonra hürriyetlerini daha sonrada istiklâl ve istikbâllerini kaybetmeye mahkumdurlar.*

*Nations who make habit of living comfortably without learning, hard work and tiring will first lose their dignity, then their freedom and ultimately their liberty.*

*M. Kemal ATATÜRK*

## Hakkımızda

Temelleri 1978 yılında atılan ÖZGÜR GAZ yenilikçi anlayışı, tecrübesi ve asla ödün vermediği kalite politikası ile sektöründe lider olmayı başarmıştır. Otuz dokuz yılı aşkın süredir üretimini başarıyla sürdürmekte olan ÖZGÜR GAZ günümüz ileri mühendislik teknolojilerini kullanarak sektöre yön veren bir çok patentli tasarıma imza atmıştır.

## About Us

ÖZGÜR GAS which founded in 1978, achieved to be leader in it's sector with innovative under- standing, experience and without never sacrificing quality policy. ÖZGÜR GAS which maintain it's success for over thirty years, gathered lots of patented success that directed sector while using modern advance engineering technologies.

## Our Certificates



# INDEX İçindekiler

<b>Safety Gas Taps</b> .....	5
<i>Ventilli Gaz Muslukları</i>	
<b>Taps, Valves and Regulators</b> .....	20
<i>Musluk, Vana ve Regülatörler</i>	
<b>Fittings</b> .....	26
<i>Bağlantı Elemanları</i>	
<b>Ignition Elements</b> .....	33
<i>Ateşleme Parçaları</i>	
<b>Flex Hoses</b> .....	37
<i>Flex Hortumlar</i>	
<b>Knobs</b> .....	42
<i>Düğmeler</i>	
<b>Burners and Grills</b> .....	47
<i>Brülör ve Izgaralar</i>	
<b>Mechanical Accessories</b> .....	57
<i>Mekanik Aksesuarlar</i>	

# Safety Gas Taps

*Ventilli Gas Muslukları*



# Safety Gas Taps for Ovens

## Emniyet Ventilli Gaz Muslukları

### MODEL K20



Position Angels Pozisyon açılıarı	Materials Materyaller	General Characteristics Genel özellikler
	<p><b>Body:</b> Forged brass Gövde: Dövme Pirinç</p> <p><b>Cone:</b> Bar-cut brass Mekanizma: Çubuk Pirinç</p> <p><b>Cap:</b> Zinc alloy Kapak: Zamak</p> <p><b>Spindle:</b> Bar-cut brass Mil: Çubuk Pirinç</p>	<p><b>Max. Ambient Temperature:</b> up to 130°C Maksimum ortam ısı: 130°C</p> <p><b>Max Gas Pressure:</b> 65 mbar Maksimum gaz basıncı: 65 mbar</p> <p><b>Stroke:</b> 5,5 mm Basma: 5,5 mm</p> <p><b>Max Turning Torque of Spindle Rotation:</b> 0,2 Nm Milin maksimum dönüş torku: 0,2 Nm</p> <p><b>Max Pushing Strength:</b> 20 N Maksimum itme gücü: 20 N</p> <p><b>Outlet Types:</b> M16x1,5 Çıkış ölçüsü: M16x1,5</p> <p><b>Inlet Types:</b> M16x1,5 Giriş Ölçüsü: M16x1,5</p> <p><b>Spindle Dimensions:</b> Ø6 or Ø8 mm Mil ölçüsü: Ø6 or Ø8 mm</p> <p><b>Screw Connection Dimensions:</b> M8x1 or M9x1 Termokupl bağlantı ölçüleri: M8x1 or M9x1</p> <p><b>Max Torque for fitting Outlet:</b> 15 Nm Gaz çıkışı için maksimum tork: 15 Nm</p> <p><b>Max Torque for Gas Inlet:</b> 15 Nm Gaz girişi için maksimum tork: 15 Nm</p>
Technical Dimensions Teknik ölçüler	Screw Connection Termokupl bağlantısı	

# Safety Gas Taps for Ovens

Emniyet Ventilli Gaz Muslukları

## MODEL K21



Position Angels Pozisyon açıları	Materials Materyaller	General Characteristics Genel özellikler
	<p><b>Body:</b> Forged brass Gövde: Dövme Pirinç</p> <p><b>Cone:</b> Bar-cut brass Mekanizma: Çubuk Pirinç</p> <p><b>Cap:</b> Zinc alloy Kapak: Zamak</p> <p><b>Spindle:</b> Bar-cut brass Mil: Çubuk Pirinç</p>	<p><b>Max. Ambient Temperature:</b> up to 130°C Maksimum ortam isisi</p> <p><b>Max Gas Pressure:</b> 65 mbar Maksimum gaz basıncı</p> <p><b>Stroke:</b> 5,5 mm Basma</p> <p><b>Max Turning Torque of Spindle Rotation:</b> 0,2 Nm Milin maksimum dönüş torku</p> <p><b>Max Pushing Strength:</b> 20 N Maksimum itme gücü</p> <p><b>Outlet Types:</b> M16x1,5 Çıkış ölçüsü</p> <p><b>Inlet Types:</b> M16x1,5 Giriş ölçüsü</p> <p><b>Spindle Dimensions:</b> Ø6 or Ø8 mm Mil ölçüsü:</p> <p><b>Screw Connection Dimensions:</b> M8x1 or M9x1 Termokupl bağlantı ölçüleri</p> <p><b>Max Torque for fitting Outlet:</b> 15 Nm Gaz çıkışı için maksimum tork</p> <p><b>Max Torque for Gas Inlet:</b> 15 Nm Gaz girişi için maksimum tork</p>

Technical Dimensions Teknik ölçüler	Screw Connection Termokupl bağlantısı

# Safety Gas Taps for Ovens

Emniyet Ventilli Gaz Muslukları

## MODEL C20



Position Angels Pozisyon açıları	Materials Materiyaller	General Characteristics Genel özellikler
<p>Open Max. 90°</p> <p>Closed 0°</p> <p>Open Min. 150°</p>	<p>Body: <b>Forged brass</b> Gövde: <b>Dövme Pirinç</b></p> <p>Cone: <b>Bar-cut brass</b> Mekanizma: <b>Çubuk Pirinç</b></p> <p>Cap: <b>Zinc alloy</b> Kapak: <b>Zamak</b></p> <p>Spindle: <b>Bar-cut brass</b> Mil: <b>Çubuk Pirinç</b></p>	<p>Max. Ambient Temperature: <b>up to 130°C</b> Maksimum ortam ısı: <b>130°C</b></p> <p>Max Gas Pressure: <b>65 mbar</b> Maksimum gaz basıncı: <b>65 mbar</b></p> <p>Stroke: <b>5,5 mm</b> Basma: <b>5,5 mm</b></p> <p>Max Turning Torque of Spindle Rotation: <b>0,2 Nm</b> Milin maksimum dönüş torku: <b>0,2 Nm</b></p> <p>Max Pushing Strength: <b>20 N</b> Maksimum itme gücü: <b>20 N</b></p> <p>Outlet Types: <b>M16x1,5</b> Çıkış ölçüsü: <b>M16x1,5</b></p> <p>Inlet Types: <b>Clamp Connection</b> Giriş ölçüsü: <b>Clamp Connection</b></p> <p>Spindle Dimensions: <b>Ø6 or Ø8 mm</b> Mil ölçüsü: <b>Ø6 or Ø8 mm</b></p> <p>Screw Connection Dimensions: <b>M8x1 or M9x1</b> Termokupl bağlantı ölçüleri: <b>M8x1 or M9x1</b></p> <p>Max Torque for fitting Outlet: <b>15 Nm</b> Gaz çıkışı için maksimum tork: <b>15 Nm</b></p> <p>Max Torque for Gas Inlet: <b>15 Nm</b> Gaz girişi için maksimum tork: <b>15 Nm</b></p>

Technical Dimensions Teknik ölçüler	Screw Connection Termokupl bağlantısı
<p>56</p> <p>17</p> <p>M16x1,5 BRULOR OUTLET</p> <p>M9x1 Thermocouple</p> <p>Stroke</p> <p>6,50</p> <p>PIPE Ø22</p> <p>Ø8</p> <p>28</p> <p>31</p> <p>22,50</p> <p>51</p> <p>BYPASS</p>	<p>THERMOCOUPLE</p> <p>A</p> <p>A</p> <p>SECTION A-A</p>

# Safety Gas Taps for Ovens

Emniyet Ventilli Gaz Muslukları

## MODEL C21



Position Angels Pozisyon açıları	Materials Materiyaller	General Characteristics Genel özellikler
<p>Pilot Open 30° Closed 0° Open Max. 90° Open Min. 150°</p>	<p><b>Body:</b> Forged brass Gövde: Dövme Pirinç</p> <p><b>Cone:</b> Bar-cut brass Mekanizma: Çubuk Pirinç</p> <p><b>Cap:</b> Zinc alloy Kapak: Zamak</p> <p><b>Spindle:</b> Bar-cut brass Mil: Çubuk Pirinç</p>	<p><b>Max. Ambient Temperature:</b> up to 130°C Maksimum ortam ısı: 130°C</p> <p><b>Max Gas Pressure:</b> 65 mbar Maksimum gaz basıncı: 65 mbar</p> <p><b>Stroke:</b> 5,5 mm Basma: 5,5 mm</p> <p><b>Max Turning Torque of Spindle Rotation:</b> 0,2 Nm Milin maksimum dönüş torku: 0,2 Nm</p> <p><b>Max Pushing Strength:</b> 20 N Maksimum itme gücü: 20 N</p> <p><b>Outlet Types:</b> M16x1,5 Çıkış ölçüsü: M16x1,5</p> <p><b>Inlet Types:</b> Clamp Connection Giriş ölçüsü: Clamp Connection</p> <p><b>Spindle Dimensions:</b> Ø6 or Ø8 mm Mil ölçüsü: Ø6 or Ø8 mm</p> <p><b>Screw Connection Dimensions:</b> M8x1 or M9x1 Termokpl bağlantı ölçüleri: M8x1 or M9x1</p> <p><b>Max Torque for fitting Outlet:</b> 15 Nm Gaz çıkışı için maksimum tork: 15 Nm</p> <p><b>Max Torque for Gas Inlet:</b> 15 Nm Gaz girişi için maksimum tork: 15 Nm</p>

Technical Dimensions Teknik ölçüler	Screw Connection Termokupl bağlantısı
<p>56 17 M16x1,5 BRULOR OUTLET M9x1 Thermocouple Stroke 6,50 Ø8 PIPE Ø22 Ø22 31 M10x1 PILOT 22,50 51 BYPASS</p>	<p>THERMOCUPLE SECTION A-A</p>

# Safety Gas Taps for Ovens

Emniyet Ventilli Gaz Muslukları

## MODEL K19



Position Angels Pozisyon açılırları	Materials Materiyaller
<p>Open Max. 90°</p> <p>Closed 0°</p> <p>Open Min. 150°</p>	<p>Body: <b>Forged brass</b> Gövde: <b>Dövme Piriç</b></p> <p>Cone: <b>Bar-cut brass</b> Mekanizma: <b>Çubuk Piriç</b></p> <p>Cap: <b>Zinc alloy</b> Kapak: <b>Zamak</b></p> <p>Spindle: <b>Bar-cut brass</b> Mil: <b>Çubuk Piriç</b></p>

### General Characteristics Genel özellikler

Max. Ambient Temperature: Maksimum ortam isisi	up to 130°C
Max Gas Pressure: Maksimum gaz basıncı	65 mbar
Stroke: Basma	5,5 mm
Max Turning Torque of Spindle Rotation: Milin maksimum dönüş torku	0,2 Nm
Max Pushing Strength: Maksimum itme gücü	20 N
Outlet Types: Çıkış ölçüsü	5/8 UNF
Inlet Types: Giriş Ölçüsü:	Clamp Connection
Spindle Dimensions: Mil ölçüsü:	Ø6 or Ø8 mm
Screw Connection Dimensions: Termokpl bağlantı ölçüleri	M8x1 or M9x1
Max Torque for fitting Outlet: Gaz çıkışı için maksimum tork	15 Nm
Max Torque for Gas Inlet: Gaz girişi için maksimum tork	15 Nm

Technical Dimensions Teknik ölçüler	Screw Connection Termokpl bağlantısı
<p>Stroke 6.50</p> <p>20</p> <p>M8x1 Thermocouple</p> <p>30.50</p> <p>PIPE Ø21</p> <p>Ø8</p> <p>BYPASS</p> <p>43</p> <p>GAS OUTLET: 5/8 UNF 7/16 UNF G1/4 M13x1 M16x1.5</p>	<p>THERMOCUPLE</p> <p>A</p> <p>A</p> <p>SECTION A-A</p>

# Safety Gas Taps for Ovens

Emniyet Ventilli Gaz Muslukları

## MODEL K18



Position Angels Pozisyon açıları	Materials Materiyaller	General Characteristics Genel özellikler
<p>Closed 0°</p> <p>Open Max. 90°</p> <p>Open Min. 150°</p>	<p>Body: Gövde: <b>Forged brass</b> Dövme Pirinç</p> <p>Cone: Mekanizma: <b>Bar-cut brass</b> Çubuk Pirinç</p> <p>Cap: Kapak: <b>Zinc alloy</b> Zamak</p> <p>Spindle: Mil: <b>Bar-cut brass</b> Çubuk Pirinç</p>	<p>Max. Ambient Temperature: Maksimum ortam ısı: <b>up to 130°C</b></p> <p>Max Gas Pressure: Maksimum gaz basıncı: <b>65 mbar</b></p> <p>Stroke: Basma: <b>5,5 mm</b></p> <p>Max Turning Torque of Spindle Rotation: Milin maksimum dönüş torku: <b>0,2 Nm</b></p> <p>Max Pushing Strength: Maksimum itme gücü: <b>20 N</b></p> <p>Outlet Types: Çıkış ölçüsü: <b>5/8 UNF</b></p> <p>Inlet Types: Giriş ölçüsü: <b>M10x1</b></p> <p>Spindle Dimensions: Mil ölçüsü: <b>Ø6 or Ø8 mm</b></p> <p>Screw Connection Dimensions: Termokupl bağlantı ölçüleri: <b>M8x1 or M9x1</b></p> <p>Max Torque for fitting Outlet Gaz çıkışı için maksimum tork: <b>15 Nm</b></p> <p>Max Torque for Gas Inlet: Gaz girişi için maksimum tork: <b>15 Nm</b></p>

Technical Dimensions Teknik ölçüler	Screw Connection Termokupl bağlantısı
<p>Stroke</p> <p>27</p> <p>M8x1 Thermocouple</p> <p>4,50</p> <p>22</p> <p>M10x1</p> <p>36,5</p> <p>BYPASS</p> <p>GAS OUTLET: 5/8 UNF 7/16 UNF G1/4 M13x1 M16x1.5</p>	<p>THERMOCUPLE</p> <p>A</p> <p>A</p> <p>SECTION A-A</p>

# High Pressure | Safety Gas Taps for Ovens

Yüksek Basıncılı | Emniyet Ventilli Gaz Muslukları

## MODEL 17-02



Position Angels Pozisyon açıları	Materials Materyaller	General Characteristics Genel özellikler
<p>Closed 0°</p> <p>Open Max. 90°</p>	<p>Body: <b>Forged brass</b> Gövde: <b>Dövme Pirinç</b></p> <p>Cone: <b>Bar-cut brass</b> Mekanizma: <b>Çubuk Pirinç</b></p> <p>Cap: <b>Bar-cut brass</b> Kapak: <b>Çubuk Pirinç</b></p> <p>Spindle: <b>Bar-cut brass</b> Mil: <b>Çubuk Pirinç</b></p>	<p>Max. Ambient Temperature: <b>up to 130°C</b> Maksimum ortam ısısı</p> <p>Max Gas Pressure: <b>65 mbar</b> Maksimum gaz basıncı</p> <p>Stroke: <b>5,5 mm</b> Basma</p> <p>Max Turning Torque of Spindle Rotation: <b>0,2 Nm</b> Milin maksimum dönüş torku</p> <p>Max Pushing Strength: <b>20 N</b> Maksimum itme gücü</p> <p>Outlet Types: <b>5/8 UNF</b> Çıkış ölçüsü</p> <p>Inlet Types: <b>G 3/8</b> Giriş Ölçüsü:</p> <p>Spindle Dimensions: <b>Ø6 or Ø8 mm</b> Mil ölçüsü:</p> <p>Screw Connection Dimensions: <b>M8x1 or M9x1</b> Termokpl bağlantı ölçüleri</p> <p>Max Torque for fitting Outlet <b>15 Nm</b> Gaz çıkışı için maksimum tork</p> <p>Max Torque for Gas Inlet: <b>15 Nm</b> Gaz girişi için maksimum tork</p>

Technical Dimensions Teknik ölçüler	Screw Connection Termokpl bağlantısı
<p>Stroke</p> <p>6,5</p> <p>46</p> <p>M8x1 Thermocouple</p> <p>45,5</p> <p>47</p> <p>GAS OUTLET : 5/8 UNF 7/16 UNF G1/4 M13x1 M16x1.5</p> <p>GAS INLET : G3/8 M14x1.5</p>	<p>THERMOCUPLE</p> <p>A</p> <p>A</p> <p>SECTION A-A</p>

# High Pressure | Safety Gas Taps for Ovens

Yüksek Basıncılı | Emniyet Ventilli Gaz Muslukları

## MODEL 18-01



Position Angels Pozisyon açıları	Materials Materiyaller	General Characteristics Genel özellikler
	<p><b>Body:</b> Forged brass Gövde: Dövme Pirinç</p> <p><b>Cone:</b> Bar-cut brass Mekanizma: Çubuk Pirinç</p> <p><b>Cap:</b> Bar-cut brass Kapak: Çubuk Pirinç</p> <p><b>Spindle:</b> Bar-cut brass Mil: Çubuk Pirinç</p>	<p><b>Max. Ambient Temperature:</b> up to 130°C Maksimum ortam ısı: 130°C</p> <p><b>Max Gas Pressure:</b> 65 mbar Maksimum gaz basıncı: 65 mbar</p> <p><b>Stroke:</b> 5,5 mm Basma: 5,5 mm</p> <p><b>Max Turning Torque of Spindle Rotation:</b> 0,2 Nm Milin maksimum dönüş torku: 0,2 Nm</p> <p><b>Max Pushing Strength:</b> 20 N Maksimum itme gücü: 20 N</p> <p><b>Outlet Types:</b> 5/8 UNF Çıkış ölçüsü: 5/8 UNF</p> <p><b>Inlet Types:</b> G 3/8 Giriş Ölçüsü: G 3/8</p> <p><b>Spindle Dimensions:</b> Ø6 or Ø8 mm Mil ölçüsü: Ø6 or Ø8 mm</p> <p><b>Screw Connection Dimensions:</b> M8x1 or M9x1 Termokpl bağlantı ölçüleri: M8x1 or M9x1</p> <p><b>Max Torque for fitting Outlet:</b> 15 Nm Gaz çıkışı için maksimum tork: 15 Nm</p> <p><b>Max Torque for Gas Inlet:</b> 15 Nm Gaz girişi için maksimum tork: 15 Nm</p>

Technical Dimensions Teknik ölçüler	Screw Connection Termokpl bağlantısı
<p><b>GAS OUTLET:</b> 5/8 UNF 7/16 UNF G1/4 M13x1 M16x1,5</p> <p><b>GAS INLET:</b> G3/8 M14x1,5</p>	<p><b>THERMOCOUPLE</b></p> <p><b>SECTION A-A</b></p>

# High Pressure | Safety Gas Taps for Ovens

Yüksek Basıncılı | Emniyet Ventilli Gaz Muslukları

## MODEL 17-45



### Position Angels Pozisyon açıları

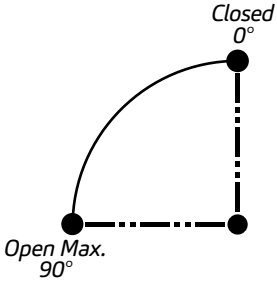

### Materials Materyaller

Body: **Forged brass**  
Gövde: **Dövme Pirinç**  
Cone: **Bar-cut brass**  
Mekanizma: **Çubuk Pirinç**  
Cap: **Bar-cut brass**  
Kapak: **Çubuk Pirinç**  
Spindle: **Bar-cut brass**  
Mil: **Çubuk Pirinç**

### General Characteristics Genel özellikler

Max. Ambient Temperature: Maksimum ortam ısı	<b>up to 130°C</b>
Max Gas Pressure: Maksimum gaz basıncı	<b>65 mbar</b>
Stroke: Basma	<b>5,5 mm</b>
Max Turning Torque of Spindle Rotation: Milin maksimum dönüş torku	<b>0,2 Nm</b>
Max Pushing Strength: Maksimum itme gücü	<b>20 N</b>
Outlet Types: Çıkış ölçüsü	<b>5/8 UNF</b>
Inlet Types: Giriş Ölçüsü:	<b>Clamp Connection</b>
Spindle Dimensions: Mil ölçüsü:	<b>Ø6 or Ø8 mm</b>
Screw Connection Dimensions: Termokupl bağlantı ölçüleri	<b>M8x1 or M9x1</b>
Max Torque for fitting Outlet: Gaz çıkışı için maksimum tork	<b>15 Nm</b>
Max Torque for Gas Inlet: Gaz girişi için maksimum tork	<b>15 Nm</b>

### Technical Dimensions Teknik ölçüler

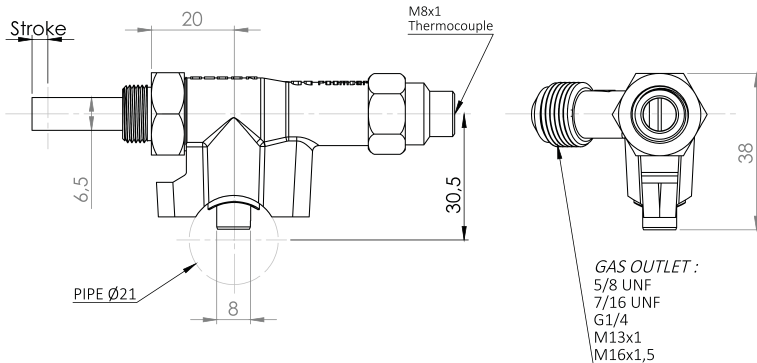

### Screw Connection Termokupl bağlantısı

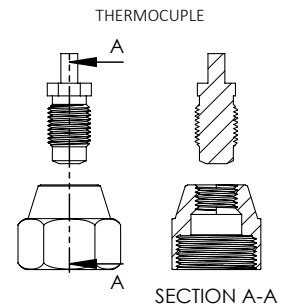

# High Pressure | Safety Gas Taps for Ovens

Yüksek Basıncılı | Emniyet Ventilli Gaz Muslukları

## MODEL 17-12



Position Angels Pozisyon açıları	Materials Materyaller	General Characteristics Genel özellikler
<p>Closed 0°</p> <p>Open Max. 90°</p>	<p>Body: Gövde: <b>Forged brass</b> Dövme Pirinç</p> <p>Cone: Mekanizma: <b>Bar-cut brass</b> Çubuk Pirinç</p> <p>Cap: Kapak: <b>Bar-cut brass</b> Çubuk Pirinç</p> <p>Spindle: Mil: <b>Bar-cut brass</b> Çubuk Pirinç</p>	<p>Max. Ambient Temperature: Maksimum ortam ısı: <b>up to 130°C</b></p> <p>Max Gas Pressure: Maksimum gaz basıncı: <b>65 mbar</b></p> <p>Stroke: Basma: <b>5,5 mm</b></p> <p>Max Turning Torque of Spindle Rotation: Milin maksimum dönüş torku: <b>0,2 Nm</b></p> <p>Max Pushing Strength: Maksimum itme gücü: <b>20 N</b></p> <p>Outlet Types: Çıkış ölçüsü: <b>M16x1,5</b></p> <p>Inlet Types: Giriş Ölçüsü: <b>M16x1,5</b></p> <p>Spindle Dimensions: Mil ölçüsü: <b>Ø6 or Ø8 mm</b></p> <p>Screw Connection Dimensions: Termokpl bağlantı ölçüleri: <b>M8x1 or M9x1</b></p> <p>Max Torque for fitting Outlet Gaz çıkışı için maksimum tork: <b>15 Nm</b></p> <p>Max Torque for Gas Inlet: Gaz girişi için maksimum tork: <b>15 Nm</b></p>

Technical Dimensions Teknik ölçüler	Screw Connection Termokupl bağlantısı
<p>Stroke</p> <p>46</p> <p>M8x1 Thermocouple</p> <p>6,5</p> <p>M16x1,5</p> <p>31,50</p> <p>M16x1,5</p>	<p>THERMOCUPLE</p> <p>A</p> <p>A</p> <p>SECTION A-A</p>

# High Pressure | Safety Gas Taps for Ovens

Yüksek Basıncılı | Emniyet Ventilli Gaz Muslukları

## MODEL 18-12



Position Angels Pozisyon açıları	Materials Materyaller	General Characteristics Genel özellikler
<p>Pilot Open 30° Closed 0° Open Max. 180°</p>	<p><b>Body:</b> Forged brass Gövde: Dövme Pirinç</p> <p><b>Cone:</b> Bar-cut brass Mekanizma: Çubuk Pirinç</p> <p><b>Cap:</b> Bar-cut brass Kapak: Çubuk Pirinç</p> <p><b>Spindle:</b> Bar-cut brass Mil: Çubuk Pirinç</p>	<p><b>Max. Ambient Temperature:</b> up to 130°C Maksimum ortam isisi</p> <p><b>Max Gas Pressure:</b> 65 mbar Maksimum gaz basıncı</p> <p><b>Stroke:</b> 5,5 mm Basma</p> <p><b>Max Turning Torque of Spindle Rotation:</b> 0,2 Nm Milin maksimum dönüş torku</p> <p><b>Max Pushing Strength:</b> 20 N Maksimum itme gücü</p> <p><b>Outlet Types:</b> M16x1,5 Çıkış ölçüsü</p> <p><b>Inlet Types:</b> M16x1,5 Giriş Ölçüsü:</p> <p><b>Spindle Dimensions:</b> Ø6 or Ø8 mm Mil ölçüsü:</p> <p><b>Screw Connection Dimensions:</b> M8x1 or M9x1 Termokupl bağlantı ölçüleri</p> <p><b>Max Torque for fitting Outlet:</b> 15 Nm Gaz çıkışı için maksimum tork</p> <p><b>Max Torque for Gas Inlet:</b> 15 Nm Gaz girişi için maksimum tork</p>

Technical Dimensions Teknik ölçüler	Screw Connection Termokupl bağlantısı
<p>Stroke 6,5 46 M8x1 Thermocouple M10x1 PILOT M16x1,5 31,5 M16x1,5</p>	<p>THERMOCOUPLE A SECTION A-A</p>

# High Pressure | Safety Gas Taps for Ovens

Yüksek Basıncılı | Emniyet Ventilli Gaz Muslukları

## MODEL 17-04



Position Angels Pozisyon açıları	Materials Materyaller	General Characteristics Genel özellikler
<p>Closed 0°</p> <p>Open Max. 90°</p>	<p>Body: Gövde: <b>Forged brass</b> Dövme Piriç</p> <p>Cone: Mekanizma: <b>Bar-cut brass</b> Çubuk Piriç</p> <p>Cap: Kapak: <b>Bar-cut brass</b> Çubuk Piriç</p> <p>Spindle: Mil: <b>Bar-cut brass</b> Çubuk Piriç</p>	<p>Max. Ambient Temperature: Maksimum ortam isisi: <b>up to 130°C</b></p> <p>Max Gas Pressure: Maksimum gaz basıncı: <b>65 mbar</b></p> <p>Stroke: Basma: <b>5,5 mm</b></p> <p>Max Turning Torque of Spindle Rotation: Milin maksimum dönüş torku: <b>0,2 Nm</b></p> <p>Max Pushing Strength: Maksimum itme gücü: <b>20 N</b></p> <p>Outlet Types: Çıkış ölçüsü: <b>5/8 UNF</b></p> <p>Inlet Types: Giriş ölçüsü: <b>1/8 NPT</b></p> <p>Spindle Dimensions: Mil ölçüsü: <b>Ø6 or Ø8 mm</b></p> <p>Screw Connection Dimensions: Termokupl bağlantı ölçüleri: <b>M8x1 or M9x1</b></p> <p>Max Torque for fitting Outlet Gaz çıkışı için maksimum tork: <b>15 Nm</b></p> <p>Max Torque for Gas Inlet: Gaz girişi için maksimum tork: <b>15 Nm</b></p>

Technical Dimensions Teknik ölçüler	Screw Connection Termokupl bağlantısı
<p>Stroke</p> <p>46</p> <p>M8x1 Thermocouple</p> <p>6,50</p> <p>25</p> <p>1/8 NPT</p> <p>33</p> <p>GAS OUTLET : 5/8 UNF 7/16 UNF G1/4 M13x1 M16x1,5</p>	<p>THERMOCOUPLE</p> <p>A</p> <p>A</p> <p>SECTION A-A</p>

# Yedek Parçalar

## Spare parts

K 20 / K 21



fig. resim	product code ürün kodu	description açıklama	thread difl	øpipe øboru
1	OZ-12-10	union nut rekor	M16x1.5	10
2	OZ-12-11	ring yüzük		10
3	OZ-12-12	welding support kaynak takozu		10
4	OZ-12-13	union nut rekor	M10x1	6
5	OZ-12-14	ring yüzük		6

C 19 / 17-45



fig. resim	product code ürün kodu	description açıklama	thread difl	øpipe øboru
1	OZ-12-10	union nut rekor	G 1/4	8
2	OZ-12-11	ring yüzük		8
3	OZ-12-17	nut somun	M13x1	
4	OZ-12-15	clamp kelepçe		1/2
5	OZ-12-16	screw vida	M5x25	

C 20 / C 21



fig. resim	product code ürün kodu	description açıklama	thread difl	øpipe øboru
1	OZ-12-10	union nut rekor	M16x1.5	10
2	OZ-12-11	ring yüzük		10
3	OZ-12-13	union nut rekor	M10x1	6
4	OZ-12-14	ring yüzük		6
5	OZ-12-15	clamp kelepçe		1/2
6	OZ-12-16	screw vida	M5x25	

18-17 / 17-12



fig. resim	product code ürün kodu	description açıklama	thread difl	øpipe øboru
1	OZ-12-10	union nut rekor	M16x1.5	10
2	OZ-12-11	ring yüzük		10
3	OZ-12-12	welding support kaynak takozu		10
4	OZ-12-13	union nut rekor	M10x1	6
5	OZ-12-14	ring yüzük		6
6	OZ-12-17	nut somun	M14x1	

18-01 / 17-02



fig. resim	product code ürün kodu	description açıklama	thread difl	øpipe øboru
1	OZ-12-01	union nut rekor	5/8 UNF	10
2	OZ-12-18	welding support kaynak takozu	G 3/8	10
3	OZ-12-17	nut somun	M14x1	
4	OZ-12-13	union nut rekor	M10x1	6
5	OZ-12-14	ring yüzük		6

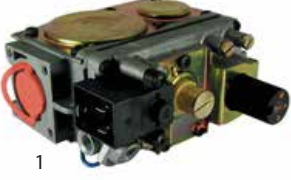

fig. resim	product code ürün kodu	description açıklama	model model
1	OZ-18-50	magnet unit magnet bobin	K20 / K21 / C20 / C21
2	OZ-18-51	magnet unit magnet bobin	K19 / 18-01 / 17-02 / 17-45

# Thermostatic Gas Valves

## Termostatik Gaz Muslukları

NOVASIT Gas Valve  
NOVASIT Gaz Valfi



part code parça kodu	power supply güç	frequency frekans	gas input gaz girişi	gas output gaz çıkışı	therm. con. term. bağ.
OZ.820	230 V	50 Hz	1/2"	1/2"	M9x1

EUROSIT Gas Valve  
EUROSIT Gaz Valfi



part code parça kodu	temperature °C derece °C	gas inp. gaz giriş	gas outp. gaz çıkış	therm. con. term. bağ.	probe length (mm) prop boyu (mm)	øprobe (mm) øprop (mm)	capillary length (mm) kapiler boyu (mm)
EURO.630	60-300	3/8"	3/8"	M9x1	72	4	1000

Limit Thermostats  
Limit Termostatlar



no.	part code parça kodu	temperature sıcaklık °C	capacity güç	bulb (mm) prop (mm)	total length (mm) toplam boy (mm)
1	LT.01	110	16A	6x100	1000
2	LT.02	230	16A	6x100	1000

Thermostats  
Termostatlar



no.	part code parça kodu	temperature range sıcaklık aralığı °C	capacity güç	bulb (mm) prop (mm)	total length (mm) toplam boy (mm)
1	TERM.01	30-90	16A	6x100	1000
2	TERM.02	30-110	16A	6x100	1000
3	TERM.03	30-120	16A	6x100	1000
4	TERM.04	50-300	16A	6x100	1000

# Taps, Valves and Regulators

*Musluk, Vana ve Regülatörler*

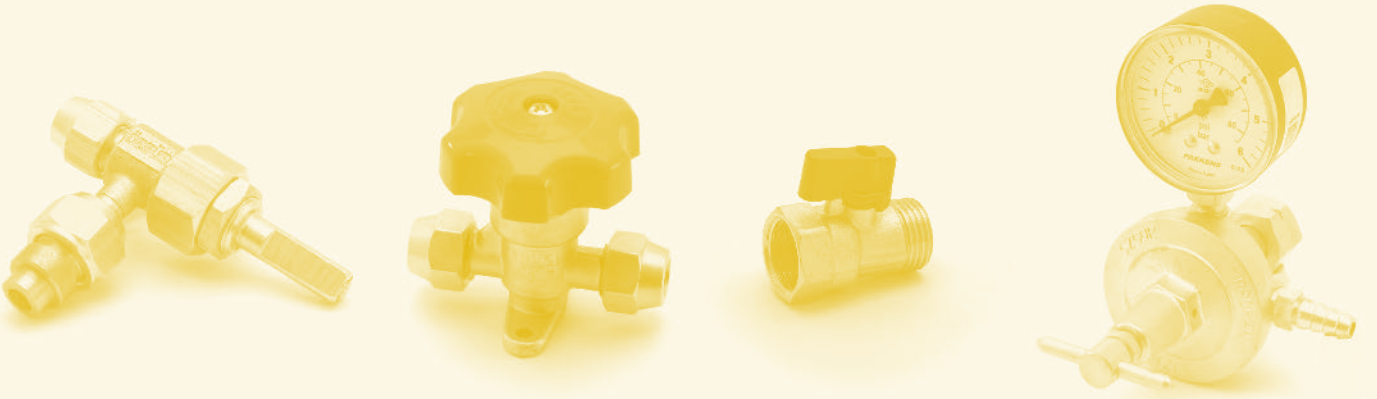

# Natural Gas & LPG Taps

## Doğal Gaz & LPG Musluklar



Product code Ürün kodu	Product name Ürün adı	Gas inlet Gaz girişi	Knob group Düğme grubu	Shaft Kuyruk
OZ-02-09	3/8 Natural gas tab with ring 3/8 Yüzlüklü doğalgaz musluğu	G 3/8"	Metall Metal	
		Gas outlet Gaz çıkışı	Polyamide Polyemid	
		5/8" UNF		



Product code Ürün kodu	Product name Ürün adı	Gas inlet Gaz girişi	Knob group Düğme grubu	Shaft Kuyruk
OZ-02-07	1/4 LPG tab with ring 1/4 Yüzlüklü LPG musluğu	M 14x1.5	Metall Metal	
		Gas outlet Gaz çıkışı	Polyamide Polyemid	
		7/16" UNF		



Product code Ürün kodu	Product name Ürün adı	Gas inlet Gaz girişi
OZ-02-20	Tea Machine Tap Kahveci Ocak Musluğu	M10x1
		Gas outlet Gaz çıkışı
		7/16" UNF

Product code Ürün kodu	Product name Ürün adı	Gas inlet Gaz girişi
OZ-02-21	Cooker Tap Volkan Ocak Musluğu	Hose
		Gas outlet Gaz çıkışı
		7/16" UNF

## Valves

### Vanalar



Product code Ürün kodu	Product name Ürün adı	Gas inlet/outlet Gaz giriş/çıkış	Pipe connection Boru bağlantısı
OZ-02-01	Midst gas valve Ara vana	3/8 - 3/8	Ø 10
OZ-02-02	Midst gas valve Ara vana	5/16 - 5/16	Ø 8
OZ-02-03	Midst gas valve Ara vana	1/4 - 1/4	Ø 6



Product code Ürün kodu	Product name Ürün adı	Gas inlet/outlet Gaz giriş/çıkış
OZ-02-05	Collector gas valve Kollektör vana	1/2 - 5/16



Product code Ürün kodu	Product name Ürün adı	Gas inlet/outlet Gaz giriş/çıkış	Pipe Connection Boru Bağlantı
OZ-02-04	3 Way midst gas valve Üç yönlü ara vana	5/16	Ø 8

## Valves

### Vanalar



Product code Ürün kodu	Product name Ürün adı	Gas inlet/outlet Gaz giriş/çıkış
OZ-02-22	Midst valve Ara kesme vanası	1/2 - 1/2



Product code Ürün kodu	Product name Ürün adı	Gas inlet/outlet Gaz giriş/çıkış
OZ-02-23	Collector gas valve Kollektör vana	1/2 - 1/2



OZ-02-23



OZ-02-24

Product code Ürün kodu	Product name Ürün adı	Gas inlet/outlet Gaz giriş/çıkış
OZ-02-23	mini ball valve mini küresel vana	1/2 - 1/2
OZ-02-24	mini ball valve mini küresel vana	3/8 - 3/8

## High Pressure LPG Regulators

### Yüksek Basınç LPG Regülatörleri



OZ-01-01



OZ-01-02

Product code Ürün kodu	Product name Ürün adı	Inlet pressure Giriş basıncı	Outlet pressure Çıkış basıncı	Capacity Kapasite	Inlet connection Giriş bağlantısı	Outlet connection Çıkış bağlantısı
OZ-01-01	High pressure LPG regulator with Manometer Manometreli Yüksek basınç LPG regülatörü	0,3 - 16 bar	0 - 4 bar	0 - 18 kg/h	W21,8 x 14" LH	G 1/4" Ø10mm
OZ-01-02	High pressure LPG regulators Yüksek Basınç LPG regülatörü	0,3 - 16 bar	0 - 4 bar	0 - 18 kg/h	W21,8 x 14" LH	G 1/4" Ø10mm



Product code Ürün kodu	Product name Ürün adı	Inlet pressure Giriş basıncı	Outlet pressure Çıkış basıncı	Capacity Kapasite	Inlet connection Giriş bağlantısı	Outlet connection Çıkış bağlantısı
OZ-01-03	4 kg/h BP - 1803 Novacommet Regulator	0,5 - 4 bar	30 mbar	4 kg/h	1/4"	3/8 "

# High Pressure LPG Regulators

## Yüksek Basınç LPG Regülatörleri



Product code Ürün kodu	Product name Ürün adı	Inlet pressure Giriş basıncı	Outlet pressure Çıkış basıncı	Capacity Kapasite	Inlet connection Giriş bağlantısı	Outlet connection Çıkış bağlantısı
OZ-01-04	High pressure Numbered LPG regulators Yüksek Basınç Numaralı LPG regülatörü	0,3 - 16 bar	0 - 2 bar	4 kg/h	W21,8 x 14" LH	8mm (M11x1)



Product code Ürün kodu	Product name Ürün adı	Inlet pressure Giriş basıncı	Outlet pressure Çıkış basıncı	Capacity Kapasite	Inlet connection Giriş bağlantısı	Outlet connection Çıkış bağlantısı
OZ-01-05	Cooker Metal Body lock Regulator Ocak Metal Gövdeli Kilitlemeli Dedantör	0,3 - 7,5 bar	29 mbar	1 kg/h	16mm G.50	10mm H.51



Product code Ürün kodu	Product name Ürün adı	Inlet pressure Giriş basıncı	Outlet pressure Çıkış basıncı	Capacity Kapasite	Inlet connection Giriş bağlantısı	Outlet connection Çıkış bağlantısı
OZ-01-06	High pressure Numbered LPG regulators Yüksek Basınç Numaralı LPG regülatörü	0,3 - 16 bar	0,2 bar	8 kg/h	16mm	8mm

# Fittings

*Baęlantı Elemanları*



# Fittings

## Bağlantı Elemanları

### "T" Group "T" Grubu



OZ-03-01



OZ-03-04



OZ-03-06



OZ-03-07

Picture No Resim Nr.	Product code Ürün kodu	Product name Ürün adı
1	OZ-03-01	3/8 "T" with nut 3/8 "T" somunlu
	OZ-03-02	5/16 "T" with nut 5/16 "T" somunlu
	OZ-03-03	1/4 "T" with nut 1/4 "T" somunlu
2	OZ-03-04	1/2 female "T" 1/2 dişi "T"
3	OZ-03-05	1/4 double ramp with nut 1/4 çiftli rampa somunlu
	OZ-03-06	3/8 double ramp with nut 3/8 çiftli rampa somunlu
4	OZ-03-07	3/8 pinion with nut 3/8 istavroz somunlu
	OZ-03-08	5/16 pinion with nut 5/16 istavroz somunlu
	OZ-03-09	1/4 pinion with nut 1/4 istavroz somunlu

### "L" Group "L" Grubu



OZ-04-01



OZ-04-04



OZ-04-05



OZ-04-06



OZ-04-09



OZ-04-11

Picture NO Resim Nr.	Product code Ürün kodu	Product name Ürün adı
1	OZ-04-01	3/8 "L" with nut 3/8 "L" somunlu
	OZ-04-02	5/16 "L" with nut 5/16 "L" somunlu
	OZ-04-03	1/4 "L" with nut 1/4 "L" somunlu
2	OZ-04-04	1/2 right - left "L" 1/2 sağ - sol "L"
	OZ-04-10	1/2 - 1/8 "L" 1/2 - 1/8 "L"
3	OZ-04-05	1/2 female elbow 1/2 dişi dirsek
4	OZ-04-06	1/2 elbow with tail 1/2 kuyruklu dirsek
	OZ-04-07	3/8 male 1/2 female elbow with tail 3/8 erkek 1/2 dişi kuyruklu dirsek
	OZ-04-08	3/8 elbow with tail 3/8 kuyruklu dirsek
5	OZ-04-09	3/8 elbow with ring 3/8 yüzüklü dirsek
6	OZ-04-11	1/4 hose "L" with nut 1/4 hortum "L" somunlu

# Fittings

## Bağlantı Elemanları

### Footed Regulator Rakor

Ayaklı Regülatör Rekoru



OZ-05-01

Picture No Resim Nr.	Product code Ürün kodu	Product name Ürün adı
1	OZ-05-01	3/8 Footed regulator rakors with nut 3/8 Ayaklı regülatör rekoru somunlu
	OZ-05-02	5/16 Footed regulator rakors with nut 5/16 Ayaklı regülatör rekoru somunlu
	OZ-05-03	1/4 Footed regulator rakors with nut 1/4 Ayaklı regülatör rekoru somunlu

### Nozzle Unions

Memeli Ünyonlar



OZ-06-01



OZ-06-05

Picture No Resim Nr.	Product code Ürün kodu	Product name Ürün adı
1	OZ-06-01	1/4-1/4 Nozzle union with nut 1/4-1/4 Memeli ünyon somunlu
	OZ-06-02	1/4-1/8 Nozzle union with nut 1/4-1/8 Memeli ünyon somunlu
	OZ-06-03	3/8-3/8 Nozzle union with nut 3/8-3/8 Memeli ünyon somunlu
	OZ-06-04	3/8-1/4 Nozzle union with nut 3/8-1/4 Memeli ünyon somunlu
2	OZ-06-06	1/4 -1/4 1mm injectors Nozzle union with nut 1/4-1/4 1 mm Enjektörlü Memeli ünyon somunlu
	OZ-06-05	3/8 -1/4 1mm injectors Nozzle union with nut 3/8-1/4 1 mm Enjektörlü Memeli ünyon somunlu

### Hose Unions

Hortum Ünyonlar



OZ-07-01



OZ-07-06



OZ-07-11

Picture No Resim Nr.	Product code Ürün kodu	Product name Ürün adı
1	OZ-07-01	1/2 Hose union 1/2 Hortum ünyon
	OZ-07-02	3/8 Hose union with nut 3/8 Hortum ünyon somunlu
	OZ-07-03	5/16 Hose union with nut 5/16 Hortum ünyon somunlu
	OZ-07-04	1/4 Hose union with nut 1/4 Hortum ünyon somunlu
	OZ-07-05	1/4 Long hose union with nut 1/4 Uzun hortum ünyon somunlu
2	OZ-07-06	3/4 Female hose union 3/4 Dişi hortum ünyon
	OZ-07-07	1/2 Female hose union 1/2 Dişi hortum ünyon
	OZ-07-08	3/8 Female hose union 3/8 Dişi hortum ünyon
	OZ-07-09	5/16 Female hose union 5/16 Dişi hortum ünyon
	OZ-07-10	1/4 Female hose union 1/4 Dişi hortum ünyon
3	OZ-07-11	3/8 Footed with nut 3/8 Ayaklı somunlu

### Valve Rekor

Vana Rekorları



OZ-08-01



OZ-08-04

Picture No Resim Nr.	Product code Ürün kodu	Product name Ürün adı
1	OZ-08-01	1/2 -3/8 right valve rakor 1/2 - 3/8 sağ vana rekoru
	OZ-08-02	1/2 - 5/16 right valve rakor 1/2 - 5/16 sağ vana rekoru
	OZ-08-03	1/2 - 1/4- right valve rakor 1/2 - 1/4 sağ vana rekoru
	OZ-08-05	1/2 - 3/8 left valve rakor 1/2 - 3/8 sol vana rekoru
	OZ-08-06	1/2 - 5/16 left valve rakor 1/2 - 5/16 sol vana rekoru
	2	OZ-08-04

# Fittings

## Bağlantı Elemanları

### Nipples

#### Nipeller



Picture No Resim Nr.	Product code Ürün kodu	Product name Ürün adı
1	OZ-09-01	1/2-1/2 Right - left nipple 1/2-1/2 Sağ - sol nipel
	OZ-09-02	1/2-3/8 Right - left nipple 1/2-3/8 Sağ - sol nipel
	OZ-09-03	1/2-5/16 Right - left nipple 1/2-5/16 Sağ - sol nipel
	OZ-09-04	1/2-1/2 Right - right nipple 1/2-1/2 Sağ - sağ nipel
2	OZ-09-05	1/2-3/8 Right - right nipple 1/2-3/8 Sağ - sağ nipel
	OZ-09-06	1/2-5/16 Right - right nipple 1/2-5/16 Sağ - sağ nipel
3	OZ-09-07	1/2-1/4 Manometer nipple 1/2-1/4 Manometre nipel

### Regulator Outputs

#### Regülatör Çıkışları



Picture No Resim Nr.	Product code Ürün kodu	Product name Ürün adı
1	OZ-10-01	3/8-1/4 Regulator output with nut 3/8-1/4 Regülatör çıkışı somunlu
	OZ-10-02	3/8-M11x1 Regulator output with nut 3/8-M11x1 Regülatör çıkışı somunlu
	OZ-10-03	3/8-1/8 Regulator output with nut 3/8-1/8 Regülatör çıkışı somunlu
	OZ-10-04	5/16-1/4 Regulator output with nut 5/16-1/4 Regülatör çıkışı somunlu
	OZ-10-05	1/4-1/4 Regulator output with nut 1/4-1/4 Regülatör çıkışı somunlu
2	OZ-10-06	3/8 Novacommet Regulator output with nut 3/8 Novakomet regülatör çıkışı somunlu
	OZ-10-07	Hose Novacommet Regulator output Hortum Novakomet regülatör çıkışı
3	OZ-10-08	Throat Shaft novacommet Regulator output Boğaz mili novakomet regülatör çıkışı
	OZ-10-09	1/2-M11x1 Straight Regulator output 1/2-M11x1 Düz regülatör çıkışı
	OZ-10-10	1/2-1/4 Straight Regulator output 1/2-1/4 Düz regülatör çıkışı
	OZ-10-11	1/2-3/8 Straight Regulator output 1/2-3/8 Düz regülatör çıkışı

### Ramp Outputs

#### Rampa Çıkışları



Picture No Resim Nr.	Product code Ürün kodu	Product name Ürün adı
1	OZ-13-01	1/4 Single ramp output with nut 1/4 Tekli Rampa çıkışı somunlu
	OZ-13-03	3/8 Single ramp output with nut 3/8 Tekli Rampa çıkışı somunlu
2	OZ-13-02	1/4 Single ramp output Hose 1/4 Tekli Rampa çıkışı hortum
	OZ-13-04	3/8 Single ramp output Hose 3/8 Tekli Rampa çıkışı hortum

### Valve Rakors

#### Valf Rekorları



Picture No Resim Nr.	Product code Ürün kodu	Product name Ürün adı
1	OZ-14-01	3/8 Male - 1/4 Female valve rakor with nut 3/8 Erkek - 1/4 Dişi valf rekoru somunlu
	OZ-14-02	3/8 Male - 1/4 Female valve rakor with nut 3/8 Erkek - 1/4 Dişi valf rekoru somunlu
	OZ-14-03	3/8 Male - M13x1 Female valve rakor with nut 3/8 Erkek - M13x1 Dişi valf rekoru somunlu
2	OZ-14-04	1/4 Male - 1/4 Female valve rakor with nut 1/4 Erkek - 1/4 Dişi valf rekoru somunlu
	OZ-14-05	1/4 Male - 1/4 Female valve rakor with nut 1/4 Erkek - 1/4 Dişi valf rekoru somunlu
	OZ-14-06	1/4 Male - M13x1 Female valve rakor with nut 1/4 Erkek - M13x1 Dişi valf rekoru somunlu

# Fittings

## Bağlantı Elemanları

### Addings & Reductions

#### Ekleme ve Redüksiyonlar



OZ-11-01

OZ-11-04

OZ-11-07

Picture No Resim Nr.	Product code Ürün kodu	Product name Ürün adı
1	OZ-11-01	3/8-3/8 Adding with nut 3/8-3/8 Ekleme somunlu
	OZ-11-02	5/16-5/16 Adding with nut 5/16-5/16 Ekleme somunlu
	OZ-11-03	1/4-1/4 Adding with nut 1/4-1/4 Ekleme somunlu
2	OZ-11-04	3/8-5/16 Reduction with nut 3/8-5/16 Redüksiyon somunlu
	OZ-11-05	3/8-1/4 Reduction with nut 3/8-1/4 Redüksiyon somunlu
	OZ-11-06	5/16-1/4 Reduction with nut 5/16-1/4 Redüksiyon somunlu
3	OZ-11-07	3/8-3/8 Footed Adding with nut 3/8-3/8 Ayaklı Ekleme somunlu

### Rakors (Nuts)

#### Rekorlar (Somunlar)



OZ-12-01

OZ-12-04

OZ-12-07

Picture No Resim Nr.	Product code Ürün kodu	Product name Ürün adı
1	OZ-12-01	3/8 Rakor 3/8 Rekor
	OZ-12-02	5/16 Rakor 5/16 Rekor
	OZ-12-03	1/4 Rakor 1/4 Rekor
2	OZ-12-04	3/8 Blind rakor 3/8 Kör rekor
	OZ-12-05	5/16 Blind rakor 5/16 Kör rekor
	OZ-12-06	1/4 Blind rakor 1/4 Kör rekor
3	OZ-12-07	1/2 Left Rakor 26 mm 1/2 Sol rekor 26 mm
	OZ-12-08	1/2 Left Rakor 27 mm 1/2 Sol rekor 27 mm

### Sleeves

#### Manşonlar



OZ-15-01

Picture No Resim Nr.	Product code Ürün kodu	Product name Ürün adı
1	OZ-15-01	1/4-1/4 Sleeve 1/4-1/4 Manşon
	OZ-15-03	3/8-3/8 Sleeve 3/8-3/8 Manşon
	OZ-15-02	1/2-1/2 Sleeve 1/2-1/2 Manşon
	OZ-15-04	3/4-1/2 Sleeve 3/4-1/2 Manşon

### Burner

#### Brülör



OZ-15-01

Picture No Resim Nr.	Product code Ürün kodu	Product name Ürün adı
1	OZ-16-02	Coffee maker burner Kahveci ocağı brülörü

### Nozzles

Enjektörler



Product code Ürün kodu	Product name Ürün adı	Hole Diameter delik çapı
M-01	M8 x 0.75 LNG Nozzles M8 x 0.75 LNG Enjektör	0.70 mm
M-02		0.80 mm
M-03		0.90 mm
M-04		1 mm
M-05		1.35 mm
M-06		1.50 mm
M-07		1.80 mm
M-08		2 mm
M-09		2.20 mm
M-10		2.50 mm
M-11		2.70 mm
M-12		3 mm

Product code Ürün kodu	Product name Ürün adı	Hole Diameter delik çapı
M-20	M4.5 x 0.5 LPG Nozzles M4.5 x 0.5 LPG Enjektör	0.40 mm
M-21		0.50 mm
M-22		0.60 mm
M-23		0.70 mm
M-24		0.80 mm
M-25		0.90 mm
M-26		1 mm
M-27		1.10 mm
M-28		1.20 mm
M-29		1.40 mm
M-30		1.50 mm
M-31	2 mm	

### Flat Radiator Nut

Düz Radyatör Rekoru



### Corner Radiator Nut

Köşe Radyatör Rekoru



Product code Ürün kodu	Product name Ürün adı
DRT-01	1/2 Flat Radiator Nut 1/2 Düz Radyatör Rekoru
DRT-02	3/4 Flat Radiator Nut 3/4 Düz Radyatör Rekoru
DRT-03	1" Flat Radiator Nut 1" Düz Radyatör Rekoru

Product code Ürün kodu	Product name Ürün adı
KRT-01	1/2 Corner Radiator Nut 1/2 Köşe Radyatör Rekoru
KRT-02	3/4 Corner Radiator Nut 3/4 Köşe Radyatör Rekoru
KRT-03	1" Corner Radiator Nut 1" Köşe Radyatör Rekoru

## Cooker Hose Inlets

### Ocak Hortum Girişleri



1



2



3

Picture No Resim Nr.	Product code Ürün kodu	Product name Ürün adı
1	OZ-04-20	3/8 Cooker Hose Inlet 3/8 Ocak Hortum Girişi
	OZ-04-21	1/2 Oven Hose Inlet 1/2 Fırın Hortum Girişi
2	OZ-04-22	1/2 - 1/2 Elbow 1/2 - 1/2 Dirsek
	OZ-04-23	1/2 - 3/8 Elbow 1/2 - 3/8 Dirsek
3	OZ-04-24	1/2 straight hose inlet 1/2 düz hortum girişi



1



2



3



4



5



6

Picture No Resim Nr.	Product code Ürün kodu	Product name Ürün adı
1	OZ-04-15	M16 x 1,5 - 3/8 Union Elbow M16 x 1,5 - 3/8 Ünyon Dirsek
2	OZ-04-12	3/8 - 3/8 Union Elbow 3/8 - 3/8 Ünyon Dirsek
3	OZ-04-16	1/4 - 1/4 Union Elbow 1/4 - 1/4 Ünyon Dirsek
4	OZ-04-13	3/8 - 1/4 Union Elbow 3/8 - 1/4 Ünyon Dirsek
5	OZ-04-17	M16 x 1,5 - ring Union Elbow M16 x 1,5 / yüzük Ünyon Dirsek
6	OZ-04-18	M16 x 1,5 - 1/4 Union Elbow M16 x 1,5 - 1/4 Ünyon Dirsek



1



2

Picture No Resim Nr.	Product code Ürün kodu	Product name Ürün adı
1	OZ-03-08	G 1/4 - 7/16 UNF T G 1/4 - 7/16 UNF T
2	OZ-03-07	Hose T HortumT

# Ignition Elements

*Ateşleme Parçaları*



# Thermocouples

## Termokupllar



no.	Product code Ürün kodu	length (mm) boy (mm)	Connection Bağlantı
1	TP-21	300	M9x1
2	TP-22	400	
3	TP-23	600	
4	TP-24	800	
5	TP-25	1000	
6	TP-26	1200	
7	TP-27	1500	

no.	Product code Ürün kodu	length (mm) boy (mm)	Connection Bağlantı
1	TP-01	300	M8x1
2	TP-02	400	
3	TP-03	600	
4	TP-04	800	
5	TP-05	1000	
6	TP-06	1200	
7	TP-07	1500	



no.	Product code Ürün kodu	length (mm) boy (mm)	Connection Bağlantı
1	TD-21	300	M9x1
2	TD-22	400	
3	TD-23	600	
4	TD-24	800	
5	TD-25	1000	
6	TD-26	1200	
7	TD-27	1500	

no.	Product code Ürün kodu	length (mm) boy (mm)	Connection Bağlantı
1	TD-01	300	M8x1
2	TD-02	400	
3	TD-03	600	
4	TD-04	800	
5	TD-05	1000	
6	TD-06	1200	
7	TD-07	1500	

## Pilots

### Pilotlar

#### Italian Pilot

##### İtalyan Kobra Pilot



Product code Ürün kodu	Ø nozzle Ø enjektör	Flame Yanış
P-01	0.20	3
P-01.1	0.25	3
P-01.2	0.35	3

#### LPG & LNG Pilot

##### LPG & LNG Pilot



Product code Ürün kodu	Ø nozzle Ø enjektör	Flame Yanış
P-02	0.20	2
P-02.1	0.25	2
P-02.2	0.35	2

#### Deep Fryer Pilot

##### Fritöz Pilot



Product code Ürün kodu	Ø nozzle Ø enjektör	Flame Yanış
P-03	0.20	1
P-03.1	0.25	1
P-03.2	0.35	1

#### Y Type Pilot

##### Y tipi pilot



Product code Ürün kodu	Ø nozzle Ø enjektör	Flame Yanış
P-04	0.20	2
P-04.1	0.25	2
P-04.2	0.35	2

#### Inox Pilot

##### inox Pilot



Product code Ürün kodu	Ø nozzle Ø enjektör	Flame Yanış
P-05	0.20	3
P-05.1	0.25	3
P-05.2	0.35	3

#### Big Gas Pilot

##### Gagalı Pilot



Product code Ürün kodu	Ø nozzle Ø enjektör	Flame Yanış
P-06	0.20	3
P-06.1	0.25	3
P-06.2	0.35	3

## Ignition parts

### Ateşleme parçaları



Product code Ürün kodu	Product name Ürün İsmi
P-06	Mechanical lighter Mekanik çakmak



Product code Ürün kodu	Product name Ürün İsmi
P-09	Gear spark plug Pasolu buji



Product code Ürün kodu	Product name Ürün İsmi
P-07	50 cm wicker cable 50 cm Hasırlı Kablo
P-08	100 cm wicker cable 100 cm Hasırlı Kablo



Product code Ürün kodu	Product name Ürün İsmi
P-10	Lighter set Çakmak takımı



Product code Ürün kodu	Product name Ürün İsmi
P-11	Piezo Lighter Set Mechanic Pieza çakmak takımı



Product code Ürün kodu	Product name Ürün İsmi
P-12	Furnace Lamp Square Fırın Lambası Köşeli

# Flex Hoses

*Fleks Hortumlar*



## Stainless Steel Flex

### Paslanmaz Esnek Fleks



Product code Ürün kodu	Product name Ürün adı	Lenght (cm) Boy (cm)	Connection Bağlantı
GF-01	Stainless Steel flexible gas hose  Paslanmaz Çelik Esnek Gaz Fleksi	10	3/8 - 3/8
GF-02		20	
GF-03		30	
GF-04		40	
GF-05		50	
GF-06		60	
GF-07		70	
GF-08		80	
GF-09		90	
GF-10		100	
GF-11		110	
GF-12		120	
GF-13		130	
GF-14		140	
GF-15		150	

Product code Ürün kodu	Product name Ürün adı	Lenght (cm) Boy (cm)	Connection Bağlantı
GF-101	Stainless Steel flexible gas hose  Paslanmaz Çelik Esnek Gaz Fleksi	10	M16x1.5 / M16x1.5
GF-102		20	
GF-103		30	
GF-104		40	
GF-105		50	
GF-106		60	
GF-107		70	
GF-108		80	
GF-109		90	
GF-110		100	
GF-111		110	
GF-112		120	
GF-113		130	
GF-114		140	
GF-115		150	

Product code Ürün kodu	Product name Ürün adı	Lenght (cm) Boy (cm)	Connection Bağlantı
MGF-01	Natural Gas Flex Doğalgaz Fleksi	50	1/2 - 1/2
MGF-02		75	
MGF-03		100	
MGF-04		125	
MGF-05		150	
MGF-06		200	
MGF-07		250	
MGF-51	Natural Gas Flex Doğalgaz Fleksi	300	3/4 - 3/4
MGF-52		350	
MGF-53		400	
MGF-54		450	
MGF-55		500	
MGF-56		450	
MGF-57		500	



# Stainless Steel Flex

## Paslanmaz Esnek Fleks



Product code Ürün kodu	Product name Ürün adı	Lenght (cm) Boy (cm)	Connection Bağlantı
GF-51	Stainless Steel flexible gas hose Paslanmaz Çelik Esnek Gaz Fleksi	10	1/4 - 1/4
GF-52		20	
GF-53		30	
GF-54		40	
GF-55		50	
GF-56		60	
GF-57		70	
GF-58		80	
GF-59		90	
GF-60		100	
GF-61		110	
GF-62		120	
GF-63		130	
GF-64		140	
GF-65		150	

Product code Ürün kodu	Product name Ürün adı	Lenght (cm) Boy (cm)	Connection Bağlantı
PGF-01	Pilot Stainless Steel flexible gas hose Pilot Paslanmaz Çelik Esnek Gaz Fleksi	10	M10x1 / M10x1
PGF-02		20	
PGF-03		30	
PGF-04		40	
PGF-05		50	
PGF-06		60	
PGF-07		70	
PGF-08		80	
PGF-09		90	
PGF-10		100	
PGF-11		110	
PGF-12		120	
PGF-13		130	
PGF-14		140	
PGF-15		150	



Product code Ürün kodu	Product name Ürün adı	Lenght (cm) Boy (cm)	Connection Bağlantı
MGF-01	Macaron Type Natural Gas Flex Makaronlu Doğalgaz Fleksi	50	1/2 - 1/2
MGF-02		75	
MGF-03		100	
MGF-04		125	
MGF-05		150	
MGF-06		200	
MGF-07		250	
MGF-51	Macaron Type Natural Gas Flex Makaronlu Doğalgaz Fleksi	300	3/4 - 3/4
MGF-52		350	
MGF-53		400	
MGF-54		450	
MGF-55		500	
MGF-56		450	
MGF-57		500	

## Flex / Connection Hoses

Fleks / Domuz Kuyrukları



OZ-19-01



OZ-19-06

Product code Ürün kodu	Product name Ürün adı	Lenght (cm) Boy (cm)	Connection Bağlantı
OZ-19-01	Propane connection hose  Propan domuz kuyruğu	75	1/2 - W21,8 x 1,8 LH
OZ-19-02		100	
OZ-19-03		125	
OZ-19-04		150	
OZ-19-05		200	

Product code Ürün kodu	Product name Ürün adı	Lenght (cm) Boy (cm)	Connection Bağlantı
OZ-19-06	Propane connection hose  Propan domuz kuyruğu	75	5/16-W21,8 x 1,8 LH
OZ-19-07		100	
OZ-19-08		125	
OZ-19-09		150	
OZ-19-10		200	



OZ-20-03



OZ-21-01

Product code Ürün kodu	Product name Ürün adı	Lenght (cm) Boy (cm)	Connection Bağlantı
OZ-20-01	Propane Flex Propan fleks	50	3/8 - 3/8
OZ-20-02		75	
OZ-20-03		100	
OZ-20-04		125	
OZ-20-05		150	
OZ-20-06		200	
OZ-20-07		250	
OZ-20-08		300	
OZ-20-09		350	
OZ-20-10		400	
OZ-20-11		450	
OZ-20-12		500	

Product code Ürün kodu	Product name Ürün adı	Lenght (cm) Boy (cm)	Connection Bağlantı
OZ-21-01	Propane connection hose compensator  Propan domuz kuyruğu kompansatör	25	1/2 - 1/2
OZ-21-02		50	
OZ-21-03		75	
OZ-21-04		100	
OZ-21-05		125	
OZ-21-06		150	

## Flex Hoses Fleks Hortumlar



Product code Ürün kodu	Product name Ürün adı	Lenght (cm) Boy (cm)	Connection Bağlantı
OZ-23-01	Tressed Flex Örgülü fleks	50	3/8 - 3/8
OZ-23-02		75	
OZ-23-03		100	
OZ-23-04		125	
OZ-23-05		150	
OZ-23-06		200	
OZ-23-07		250	
OZ-23-08		300	
OZ-23-09		350	
OZ-23-10		400	
OZ-23-11		450	
OZ-23-12		500	

Product code Ürün kodu	Product name Ürün adı	Lenght (cm) Boy (cm)	Connection Bağlantı
OZ-22-06	Tressed connection hose Bezörgü domuz kuyruğu	50	5/16-W21,8 x 1,8 LH
OZ-22-07		75	
OZ-22-08		100	
OZ-22-09		125	
OZ-22-10		150	
OZ-22-11		200	



Product code Ürün kodu	Product name Ürün adı	Lenght (cm) Boy (cm)	Connection Bağlantı
OZ-24-01	Cooker- Oven natural gas connection hose Fırın - Ocak Doğalgaz Bağlantı Fleksi	50	1/2 - 1/2
OZ-24-02		75	
OZ-24-03		100	
OZ-24-04		125	
OZ-24-05		150	
OZ-24-06		200	

Product code Ürün kodu	Product name Ürün adı	Lenght (cm) Boy (cm)	Connection Bağlantı
TGF-01	Steel braided flexible gas hose Çelik Örgü Esnek Gaz Fleksi	10	3/8 - 3/8
TGF-02		20	
TGF-03		30	
TGF-04		40	
TGF-05		50	
TGF-06		60	
TGF-07		70	
TGF-08		80	
TGF-09		90	
TGF-10		100	

# Knobs

*Düğmeler*





OZ-02-11



OZ-02-12



Product code Ürün kodu	Product name Ürün adı	Diameter Çap	Color options Renkler
OZ-02-11	Özgür® Open- Close polyamide knob Özgür® Açık - Kapalı Sabit göbek polyamid düğme	Ø 73	Grey Gri
			Red Kırmızı
			Blue Mavi
			Green Yeşil
			White Beyaz

Product code Ürün kodu	Product name Ürün adı	Diameter Çap	Color options Renkler
OZ-02-12	Özgür® adjustable polyamide knob Özgür® pilotsuz ayarlı göbek polyamid düğme	Ø 73	Grey Gri
			Red Kırmızı
			Blue Mavi
			Green Yeşil
			White Beyaz



OZ-02-13



OZ-02-14



Product code Ürün kodu	Product name Ürün adı	Diameter Çap	Color options Renkler
OZ-02-13	Özgür® adjustable polyamide knob with ignition flamme Özgür® pilotlu ayarlı göbek polyamid düğme	Ø 73	Grey Gri
			Red Kırmızı
			Blue Mavi
			Green Yeşil
			White Beyaz

Product code Ürün kodu	Product name Ürün adı	Diameter Çap	Color options Renkler
OZ-02-14	Special adjustable polyamide knob Özel ayarlı göbek polyamid düğme	Ø 73	Grey Gri
			Red Kırmızı
			Blue Mavi
			Green Yeşil
			White Beyaz



OZ-02-10



OZ-02-15



Product code Ürün kodu	Product name Ürün adı	Diameter Çap	Color options Renkler
OZ-02-10	Classic Metall knob Klasik metal düğme	Ø 60	Black Siyah
			Red Kırmızı
			Blue Mavi

Product code Ürün kodu	Product name Ürün adı	Diameter Çap	Color options Renkler
OZ-02-15	Universall metall knob Üniversal metal düğme	Ø 59	Black Siyah
			Red Kırmızı
			Blue Mavi

## Knobs Düğmeler



OZ-02-15

Product code Ürün kodu	Product name Ürün adı	Diameter Çap	Color options Renkler
OZ-02-15	Özgür® Open- Close polyamide knob Özgür® Açık - Kapalı Sabit göbek polyamid düğme	Ø 60	Grey Gri
			Red Kırmızı
			Blue Mavi
			Green Yeşil
			White Beyaz



OZ-02-16



OZ-02-17

Product code Ürün kodu	Product name Ürün adı	Diameter Çap	Color options Renkler
OZ-02-16	Özgür® Open- Close polyamide knob Özgür® Açık - Kapalı Sabit göbek polyamid düğme	Ø 30	Grey-Black Gri-Siyah

Product code Ürün kodu	Product name Ürün adı	Diameter Çap	Color options Renkler
OZ-02-17	Special adjustable polyamide knob Özel ayarlı göbek polyamid düğme	Ø 50	Black Siyah



Product code Ürün kodu	Product name Ürün adı	Diameter Çap	Color options Renkler
OZ-02-18	Button socket Düğme soketi	Ø 6	Black Siyah
		Ø 8	
		Ø 10	

# Knobs Düğmeler



OZ-02-13

Product code Ürün kodu	Product name Ürün adı	Diameter Çap	Color options Renkler
OZ-02-13	Özgür® adjustable polyamide knob with ignition flamme Özgür® pilotlu ayarlı göbek polyamid düğme	Ø 73	Grey Gri
			Red Kırmızı
			Blue Mavi
			Green Yeşil
			White Beyaz

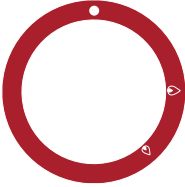

1

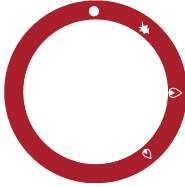

2

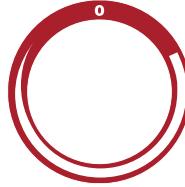

3

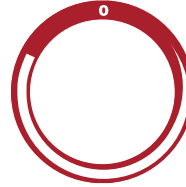

4

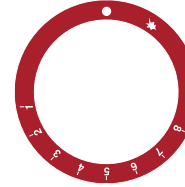

5

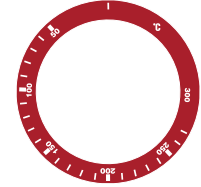

6

No	Product code Ürün kodu	Description Açıklama
1	OZ-02-13.1	gas tap without ignition flame kısık yüksek pilotsuz
2	OZ-02-13.2	gas tap with ignition flame kısık yüksek pilotlu

No	Product code Ürün kodu	Description Açıklama
3	OZ-02-13.3	down to up clockwise azdan çoğa saat yönünde
4	OZ-02-13.4	down to up counter clockwise azdan çoğa ters saatyönünde

No	Product code Ürün kodu	Description Açıklama
5	OZ-02-13.5	1-8 gas thermostat 1-8 gazlı termostat
6	OZ-02-13.6	50-300 thermostat 50-300 termostat

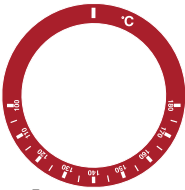

7

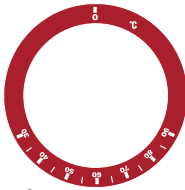

8

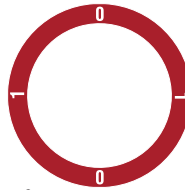

9

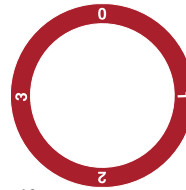

10

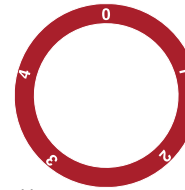

11

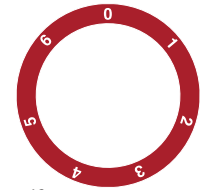

12

No	Product code Ürün kodu	Description Açıklama
7	OZ-02-13.7	100-180 thermostat 100-180 termostat
8	OZ-02-13.8	30-90 thermostat 30-90 termostat

No	Product code Ürün kodu	Description Açıklama
9	OZ-02-13.9	0-1-0-1 switch 0-1-0-1 şalter
10	OZ-02-13.10	0-1-2-3 switch 0-1-2-3 şalter

No	Product code Ürün kodu	Description Açıklama
11	OZ-02-13.11	0-1-2-3-4 switch 0-1-2-3-4 şalter
12	OZ-02-13.12	0-1-2-3-4-5-6 switch 0-1-2-3-4-5-6 şalter

# Knobs

## Düğmeler



OZ-02-13

Product code Ürün kodu	Product name Ürün adı	Diameter Çap	Color options Renkler
OZ-02-13	Özgür® adjustable polyamide knob with ignition flamme Özgür® pilotlu ayarlı göbek polyamid düğme	Ø 73	Grey Gri
			Red Kırmızı
			Blue Mavi
			Green Yeşil
			White Beyaz

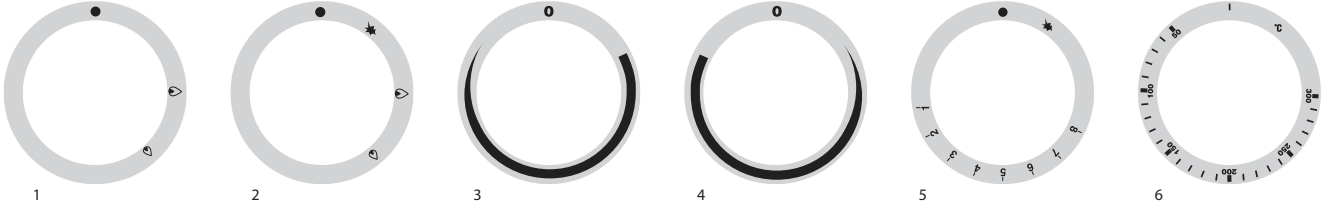

No	Product code Ürün kodu	Description Açıklama
1	OZ-02-13.1	gas tap without ignition flame kısık yüksek pilotsuz
2	OZ-02-13.2	gas tap with ignition flame kısık yüksek pilotlu

No	Product code Ürün kodu	Description Açıklama
3	OZ-02-13.3	down to up clockwise azdan çoğa saat yönünde
4	OZ-02-13.4	down to up counter clockwise azdan çoğa ters saatyönünde

No	Product code Ürün kodu	Description Açıklama
5	OZ-02-13.5	1-8 gas thermostat 1-8 gazlı termostat
6	OZ-02-13.6	50-300 thermostat 50-300 termostat

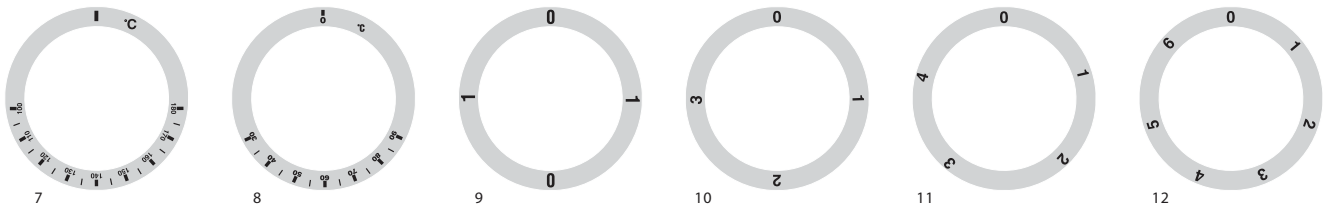

No	Product code Ürün kodu	Description Açıklama
7	OZ-02-13.7	100-180 thermostat 100-180 termostat
8	OZ-02-13.8	30-90 thermostat 30-90 termostat

No	Product code Ürün kodu	Description Açıklama
9	OZ-02-13.9	0-1-0-1 switch 0-1-0-1 şalter
10	OZ-02-13.10	0-1-2-3 switch 0-1-2-3 şalter

No	Product code Ürün kodu	Description Açıklama
11	OZ-02-13.11	0-1-2-3-4 switch 0-1-2-3-4 şalter
12	OZ-02-13.12	0-1-2-3-4-5-6 switch 0-1-2-3-4-5-6 şalter

# Burners and Grills

*Brülör ve Izgaralar*



## Burners

### Brülörler

#### Vertical burners

Dikey Brülörler



#### Horizontal burners

Yatay Brülörler



no	Product code Ürün kodu	description açıklama	cover kaplama
1	DB-001	6.0 - 6.5 KW Vertical Burner 6.0 - 6.5 KW Dikey brülör	chrome top kromajlı
2	DB-002		brass top sarı kapaklı
3	DB-003		sandy chrome top kumlu kromajlı
4	DB-004		sandy nicel top kumlu nikelli
1	DB-005	8.5 - 9.0 KW Vertical Burner 8.5 - 9.0 KW Dikey brülör	chrome top kromajlı
2	DB-006		brass top sarı kapaklı
3	DB-007		sandy chrome top kumlu kromajlı
4	DB-008		sandy nicel top kumlu nikelli
1	DB-009	10.0 - 10.5 KW Vertical Burner 10.0 - 10.5 KW Dikey brülör	chrome top kromajlı
2	DB-010		brass top sarı kapaklı
3	DB-011		sandy chrome top kumlu kromajlı
4	DB-012		sandy nicel top kumlu nikelli
1	DB-013	11.0 - 12.0 KW Vertical Burner 11.0 - 12.0 KW Dikey brülör	chrome top kromajlı
2	DB-014		brass top sarı kapaklı
3	DB-015		sandy chrome top kumlu kromajlı
4	DB-016		sandy nicel top kumlu nikelli

no	Product code Ürün kodu	description açıklama	cover kaplama
1	DB-051	6.0 - 6.5 KW Horizontal Burner 6.0 - 6.5 KW Yatay brülör	chrome top kromajlı
2	DB-052		brass top sarı kapaklı
3	DB-053		sandy chrome top kumlu kromajlı
4	DB-054		sandy nicel top kumlu nikelli
1	DB-055	8.5 - 9.0 KW Horizontal Burner 8.5 - 9.0 KW Yatay brülör	chrome top kromajlı
2	DB-056		brass top sarı kapaklı
3	DB-057		sandy chrome top kumlu kromajlı
4	DB-058		sandy nicel top kumlu nikelli
1	DB-059	10.0 - 10.5 KW Horizontal Burner 10.0 - 10.5 KW Yatay brülör	chrome top kromajlı
2	DB-060		brass top sarı kapaklı
3	DB-061		sandy chrome top kumlu kromajlı
4	DB-062		sandy nicel top kumlu nikelli
1	DB-063	11.0 - 12.0 KW Horizontal Burner 11.0 - 12.0 KW Yatay brülör	chrome top kromajlı
2	DB-064		brass top sarı kapaklı
3	DB-065		sandy chrome top kumlu kromajlı
4	DB-066		sandy nicel top kumlu nikelli



nö	Product code Ürün kodu	description açıklama	model model
1	SDB-001	LNG-LPG Burner - Super Vertical LNG-LPG Brülör - Süper dikey	No: 0
2	SDB-002		No: 1
3	SDB-003		No: 2

nö	Product code Ürün kodu	description açıklama	model model
1	SYB-001	LNG-LPG Burner - Super Horizontal LNG-LPG Brülör - Süper yatay	No: 1
2	SYB-002		No: 2



nö	Product code Ürün kodu	description açıklama	model model
1	SEB-001	LNG-LPG Burner - Super ergo LNG-LPG Brülör - Süper ergo	No: 1
2	SEB-002		No: 2
3	SEB-003		No: 3

nö	Product code Ürün kodu	description açıklama	model model
1	SB-001	LNG-LPG Burner - Super LNG-LPG Brülör - Süper	No: 1
2	SB-002		No: 2

## LPG flame slottet burners

LPG yanıřlı yarıklı brülörler

### LPG single flame slottet burners

LPG tek yanıřlı yarıklı brülörler



no	Product code Ürün kodu	Ø tap diameter (cm) Ø kapak çapı (cm)	ventury lenght (cm) venturi boyu (cm)	connection (pipe) baęlantı (boru)
1	LPG-B01	9	17	Ø 1/4"
2	LPG-B02	12	17	Ø 1/4"
3	LPG-B03	14	17	Ø 1/4"
4	LPG-B04	18	17	Ø 1/4"
5	LPG-B05	23	17	Ø 1/4"

### LPG double flame slottet burners

LPG iki yanıřlı yarıklı brülörler



no	Product code Ürün kodu	Ø tap diameter (cm) Ø kapak çapı (cm)	ventury lenght (cm) venturi boyu (cm)	connection (pipe) baęlantı (boru)
1	LPG-B06	25-12	17	Ø 1/4"

### LPG trible flame slottet burners

LPG üç yanıřlı yarıklı brülörler



no	Product code Ürün kodu	Ø tap diameter (cm) Ø kapak çapı (cm)	ventury lenght (cm) venturi boyu (cm)	connection (pipe) baęlantı (boru)
1	LPG-B07	38-24-12	17	Ø 1/4"

# LNG flame slottet burners

LNG yanıřlı yarıklı brülörler

## LNG single flame slottet burners

LNG tek yanıřlı yarıklı brülörler



no	Product code Ürün kodu	Ø tap diameter (cm) Ø kapak çapı (cm)	ventury lenght (cm) venturi boyu (cm)	connection (pipe) baęlantı (boru)
1	LNG-B01	9	17	Ø 1/4"
2	LNG-B02	12	17	Ø 1/4"
3	LNG-B03	14	17	Ø 1/4"
4	LNG-B04	18	17	Ø 1/4"
5	LNG-B05	23	17	Ø 1/4"

## LNG double flame slottet burners

LNG iki yanıřlı yarıklı brülörler



no	Product code Ürün kodu	Ø tap diameter (cm) Ø kapak çapı (cm)	ventury lenght (cm) venturi boyu (cm)	connection (pipe) baęlantı (boru)
1	LNG-B06	25-12	17	Ø 1/4"

## LNG trible flame slottet burners

LNG üç yanıřlı yarıklı brülörler



no	Product code Ürün kodu	Ø tap diameter (cm) Ø kapak çapı (cm)	ventury lenght (cm) venturi boyu (cm)	connection (pipe) baęlantı (boru)
1	LNG-B07	38-24-12	17	Ø 1/4"

## Burners

### Brülörler



no	Product code Ürün kodu	description açıklama	model model
1	SB-003	LNG-LPG Burner - Super 22 cm LNG-LPG Brülör - Süper 22 cm	No: 5

no	Product code Ürün kodu	description açıklama	model model
1	SB-004	3 way burner - Super 22 cm 3 yanışlı brülör - Süper 22 cm	No: 5



no	Product code Ürün kodu	description açıklama	model model
1	SB-005	Fryer Burner Fritöz Brülör	25 cm

no	Product code Ürün kodu	description açıklama	model model
1	SB-006	Radiant Radyan	native yerli

# LNG flame slotted burners

LNG yanışlı yarıklı brülörler

## LNG Nailed burners

LNG tırnaklı brülörler



no	Product code Ürün kodu	Ø tap diameter (cm) Ø kapak çapı (cm)	ventury lenght (cm) venturi boyu (cm)	connection (pipe) bağlantı (boru)
1	LNG-T01	9	17	Ø 1/4"
2	LNG-T02	12	17	Ø 1/4"
3	LNG-T03	14	17	Ø 1/4"
4	LNG-T04	18	17	Ø 1/4"
5	LNG-T05	23	17	Ø 1/4"

## LNG double nailed burners

LNG iki tırnaklı brülörler



no	Product code Ürün kodu	Ø tap diameter (cm) Ø kapak çapı (cm)	ventury lenght (cm) venturi boyu (cm)	connection (pipe) bağlantı (boru)
1	LNG-T06	25-12	17	Ø 1/4"

## Spare parts

Yedek parçalar



no	Product code Ürün kodu	description açıklama	ventury lenght (cm) venturi boyu (cm)	connection (pipe) bağlantı (boru)
1	LNG-101	1"Ventury with air 1" Hava ayarlı ventur	17	Ø 1/4"
2	LNG-102	Air regulator Hava ayarı	-	Ø 1/4"

## Burner Group

### Brülör Grubu

#### Oven Burner

Fırın brülör



no	Product code Ürün kodu	description açıklama
1	PFB-001	40x60 cm
2	PFB-002	30x45 cm
3	PFB-003	20x40 cm
4	PFB-004	20x30 cm

#### Stainless Steel Cake Burner

Paslanmaz pasta-börek brülör



no	Product code Ürün kodu	description açıklama
1	PBB-001	60 cm

#### Stainless Steel Cousine Burner

Paslanmaz kuzine brülör



no	Product code Ürün kodu	description açıklama
1	PKB-001	60 cm

#### Stainless Steel Oven Burner

Paslanmaz fırın brülör



no	Product code Ürün kodu	description açıklama
1	PFB-005	60 cm

#### Honeycomb Burner

Petek brülör



no	Product code Ürün kodu	description açıklama
1	PB-001	60 cm
2	PB-002	70 cm
3	PB-003	80 cm
4	PB-004	90 cm

## Cupola Group

### Döküm Grubu

#### Cupola Furnace Cover

Döküm ocak üstü



no	Product code Ürün kodu	description açıklama
1	TD-001	20 x 20 cm
2	TD-002	25 x 25 cm
3	TD-003	30 x 30 cm
4	TD-004	33 x 33 cm
5	TD-005	35 x 35 cm
6	TD-006	40 x 40 cm

#### Cupola Furnace Cover

Döküm ocak üstü



no	Product code Ürün kodu	description açıklama
1	KTD-001	25.5 x 35 cm
2	KTD-002	30.5 x 34 cm
3	KTD-003	34.5 x 43 cm
4	KTD-004	43 x 43 cm

#### Cupola Furnace Cover - Daisy

Döküm ocak üstü papatya

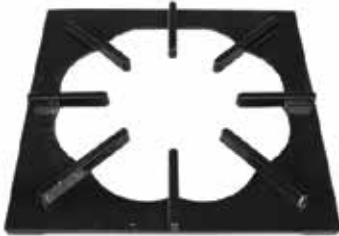

no	Product code Ürün kodu	description açıklama
1	PTD-001	40 x 40 cm
2	PTD-002	50 x 50 cm
3	PTD-003	60 x 60 cm

#### Cupola Furnace Cover - double

Döküm ocak üstü çiftli



no	Product code Ürün kodu	description açıklama
1	CD-001	600 series
2	CD-002	700 series
3	CD-003	900 series

#### Cupola Furnace Cover - double

Döküm ocak üstü çiftli



no	Product code Ürün kodu	description açıklama
1	CTD-001	36 x 58.5 cm

## Grill Group

### Izgara Grubu

#### Hamburger grill

Hamburger düz ve oluklu ızgara



no	Product code Ürün kodu	description açıklama
1	IZG-001	40 x 40 cm

#### Hamburger grill

Hamburger düz ve oluklu ızgara



no	Product code Ürün kodu	description açıklama
1	IZG-002	40 x 45 cm
2	IZG-003	50 x 80 cm

#### Hamburger grill

Hamburger oluklu ızgara



no	Product code Ürün kodu	description açıklama
1	IZG-004	25 x 42 cm

#### Lava rock grills

Lava taşı ızgara



no	Product code Ürün kodu	description açıklama
1	IZG-005	39 x 5.6 cm
2	IZG-006	42 x 5 x 6 cm
3	IZG-007	52 x 5 x 6 cm
4	IZG-008	66 x 6 cm

#### Chimney grill

Baca dökümü



no	Product code Ürün kodu	description açıklama
1	IZG-009	40 x 7 cm
2	IZG-010	40 x 10 cm

# Mechanical Accessories

*Mekanik Aksesuarlar*

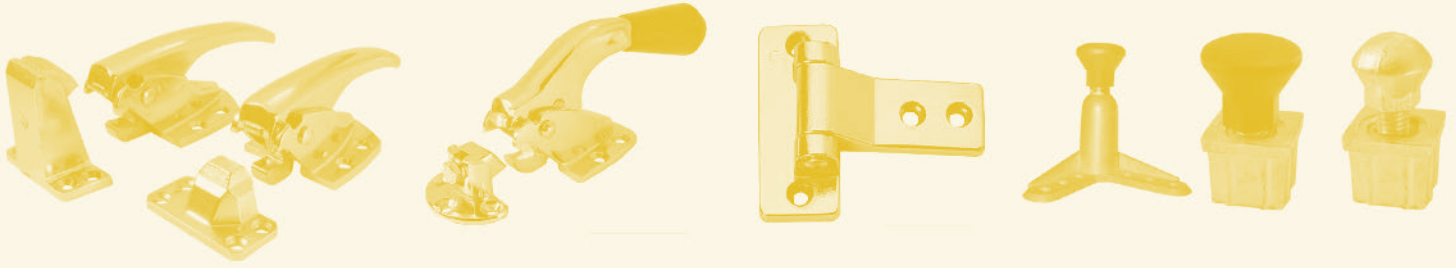

## Mechanical Accessories

### Mekanik Aksesuarlar



#### Inox leg

Inox ayak tabanlı

Product code Ürün kodu	description açıklama
MA-001	8 x 8 x 5 cm



#### Rotil leg

Rotil ayak metal

Product code Ürün kodu	description açıklama
MA-002	40 x 40 mm



#### Rotil aluminium leg

Rotil ayak alüminyum

Product code Ürün kodu	description açıklama
MA-003	40 x 40 mm
MA-004	40 x 40 mm
MA-005	40 x 40 mm



#### Metal Sheet Leg

Metal sac ayak

Product code Ürün kodu	description açıklama
MA-006	40 x 40 mm



#### Rotil plastic leg

Rotil ayak plastik

Product code Ürün kodu	description açıklama
MA-007	20 x 20 mm
MA-008	25 x 25 mm
MA-009	30 x 30 mm
MA-010	20 x 40 mm
MA-011	30 x 40 mm
MA-012	40 x 40 mm



#### Rotil plastic leg

Rotil ayak plastik

Product code Ürün kodu	description açıklama
MA-013	Ø 60 mm



### Metal Oven Handle

Metal fırın kulp

Product code Ürün kodu	description açıklama
MA-014	34.5 cm
MA-015	51 cm



### Bakalite Handle

Bakalit kulp

Product code Ürün kodu	description açıklama
MA-016	13.5 cm



### Lux Handle

Lüks kulp

Product code Ürün kodu	description açıklama
MA-017	24 cm
MA-018	30 cm
MA-019	36 cm



### Frier Basket

Fritöz sepeti

Product code Ürün kodu	description açıklama
MA-020	28x20x11 cm
MA-021	30x15x13 cm



### Rubber mounting

Lastik takoz

Product code Ürün kodu	description açıklama
MA-022	3 cm
MA-023	2 cm



### Rubber mounting

Lastik takoz

Product code Ürün kodu	description açıklama
MA-024	20 x 20 mm
MA-025	30 x 30 mm
MA-026	20 x 40 mm
MA-027	40 x 40 mm

## Mechanical Accessories

### Mekanik Aksesuarlar



#### Industrial Refrigeration Hinge

Endüstriyel buzdolabı menteşesi

Product code Ürün kodu	description açıklama
MA-028	Zamac Zamak



#### Industrial Refrigeration Hinge

Endüstriyel buzdolabı menteşesi

Product code Ürün kodu	description açıklama
MA-029	Zamac Zamak



#### Industrial Refrigeration Hinge

Endüstriyel buzdolabı menteşesi

Product code Ürün kodu	description açıklama
MA-030	
MA-031	Zamac Zamak



#### Industrial Refrigeration Hinge

Endüstriyel buzdolabı menteşesi

Product code Ürün kodu	description açıklama
MA-032	Zamac Zamak



#### Side Hinge

Yan menteşe

Product code Ürün kodu	description açıklama
MA-033	Zamac Zamak



#### Chrome drawer handle

Krom çekmece kulbu

Product code Ürün kodu	description açıklama
MA-034	Bolted - Chrome Sürgü - Krom
MA-035	Drawer - Chrome Çekmece - Krom



### Side lock

Yan kilit

Product code Ürün kodu	description açıklama
MA-036	



### Convection oven lock

Konveksiyon fırın kilidi

Product code Ürün kodu	description açıklama
MA-037	Brass Pirinç



### Convection oven lock

Konveksiyon fırın kilidi

Product code Ürün kodu	description açıklama
MA-038	Zamac Zamak



### Industrial Refrigeration Lock

Endüstriyel buzdolabı kilidi

Product code Ürün kodu	description açıklama
MA-039	Zamac Zamak



### Industrial Oven Hinge

Endüstriyel Fırın menteşesi

Product code Ürün kodu	description açıklama
MA-040	Big Büyük
MA-041	Small Küçük



### Inox Handle

İnoks kulüp

Product code Ürün kodu	description açıklama
MA-042	Zamac Zamak

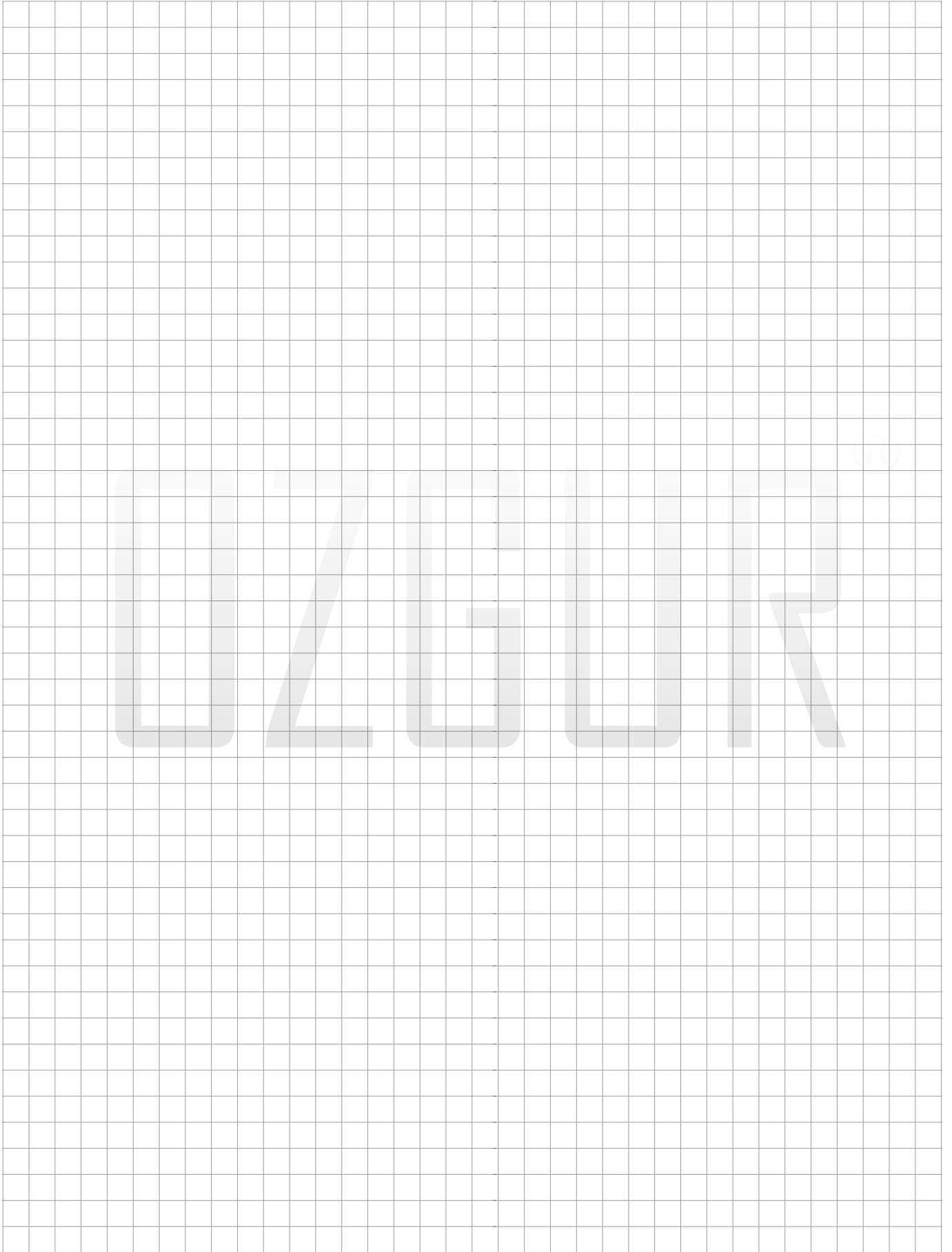



OZBUR®

**OZGUR**<sup>®</sup>

G A S A R M A T U R E S

Gürpınar Mah. 7216 Sk. No:23  
Pınarbaşı - İZMİR / TURKEY

Tel : +90 232 437 34 96

Fax : +90 232 437 34 97

[info@ozgurgaz.com](mailto:info@ozgurgaz.com)

[www.ozgurgaz.com](http://www.ozgurgaz.com)

